



CLASSIC

11003





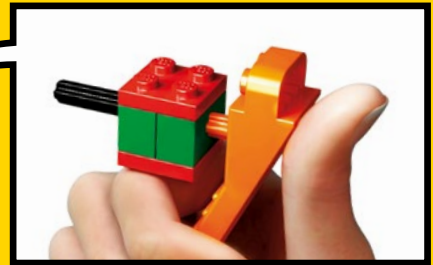

LEGO.com/brickseparator



Easy building
Einfach zu bauen
Construction facile
Costruzione facile
Construcción fácil
Construção fácil
Kezdő építőknek
Vienkarša būvēšana
简单拼砌

Page
7



Page
12



Medium building
Mittelschwer
Construction intermédiaire
Costruzione media
Construcción intermedia
Construção intermédia
Gyakorló építőknek
Vidēji sarežģīta būvēšana
中级拼砌

Page
Seite
Page
Página
Página
Página
Oldalszám
Lpp.
页码



Page
30



Page
20





Page
40



Advanced building
Fortgeschritten
Construction avancée
Costruzione avanzata
Construcción avanzada
Construção avançada
Tapasztalt építőknek
Sarežgita būvēšana
高级拼砌



Page
51



Page
63

More Ideas Online



Weitere Ideen online:
Plus d'idées en ligne :

Più idee online:

Más ideák en Internet:

Mais ideias online:

Online még több ötletet találsz:

Vairāk ideju tiešsaistē:

更多在线构思:



 [LEGO.com/classic](https://www.lego.com/classic)

1



2



3



LEGO.com/apps

Check for compatibility

Kompatibilität prüfen

Vérifier la compatibilité

Controlla la compatibilità

Comprueba tu compatibilidad

Verificar a compatibilidade

Ellenőrizd a kompatibilitást

Pārbaudīt saderību

检查兼容性



1x



2x

1

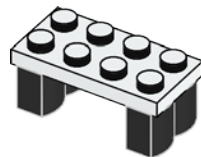

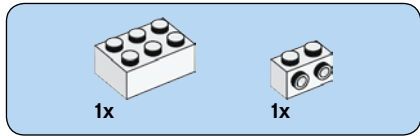

2

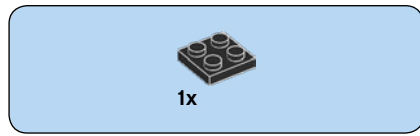
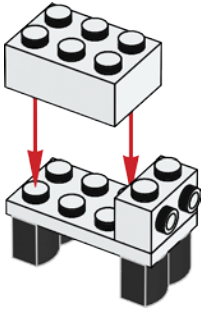

3

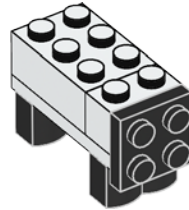



1x



2x

4

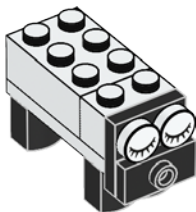

2x

5



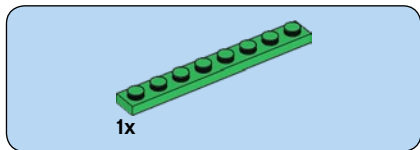
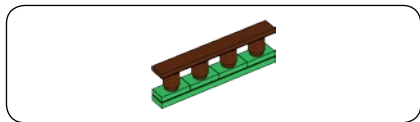

1x

6

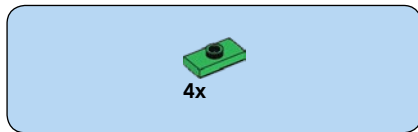
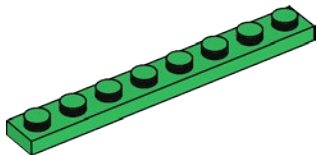

4x

7

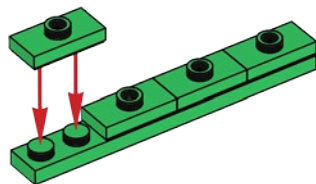

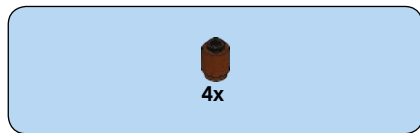

8

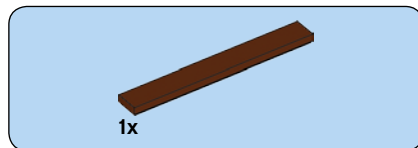
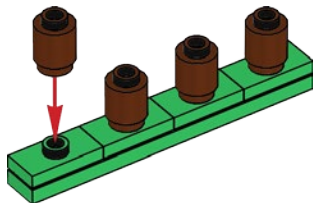

9

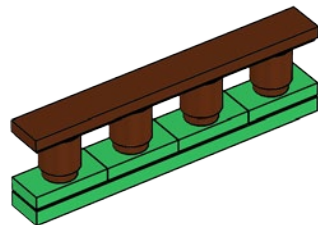

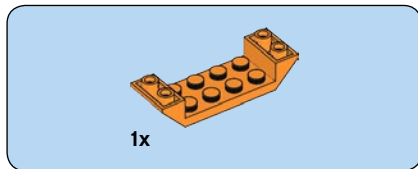

1

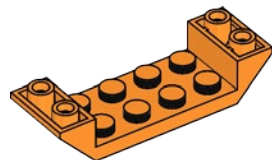

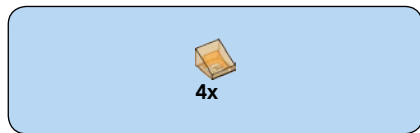

2

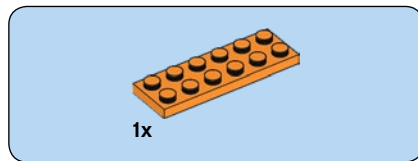
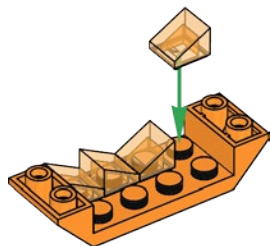

3

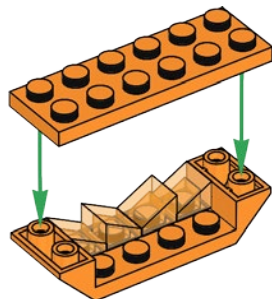



1x



1x

4

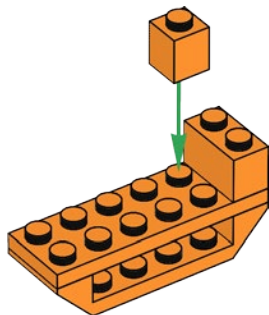



2x

5

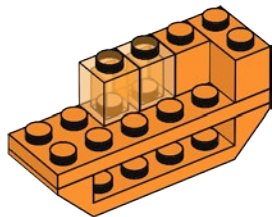

1x



1x

6

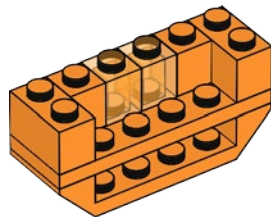



2x

7

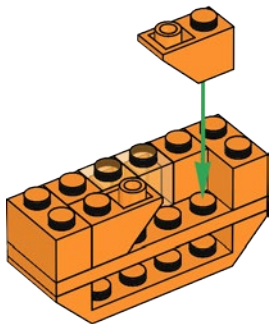

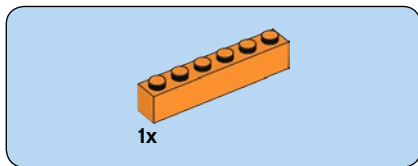

8

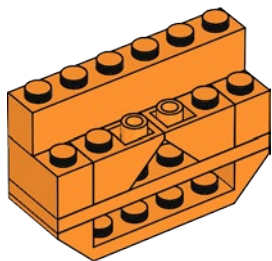

9

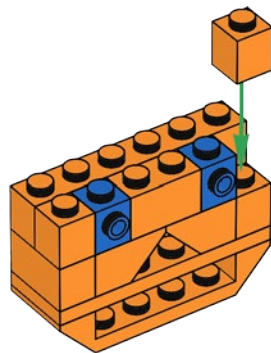

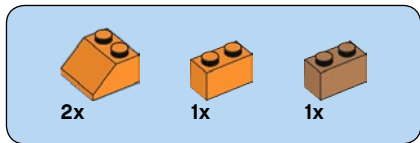

10

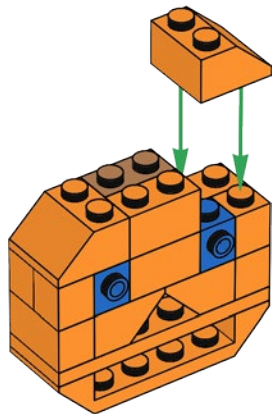



1x



1x

11

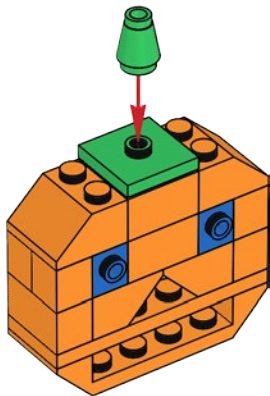

1x

12

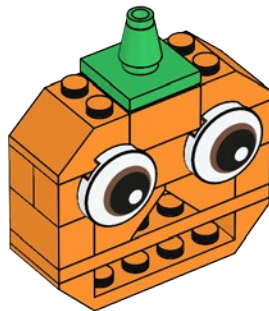

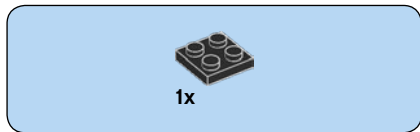

1



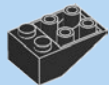

2x

2

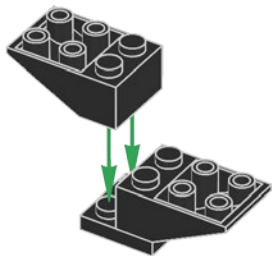

2x

3

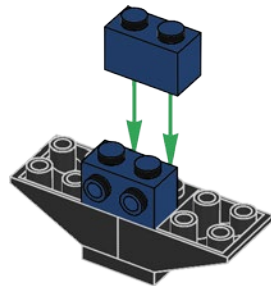



2x

4

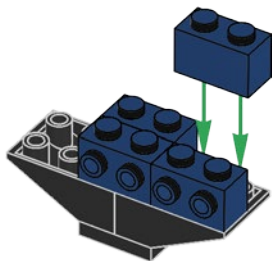



2x

5

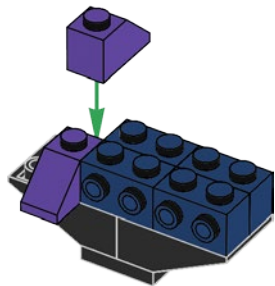

1x

6

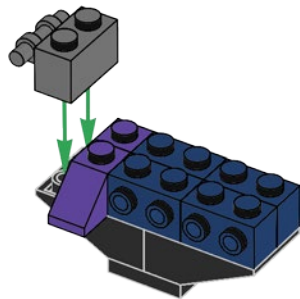



2x

7

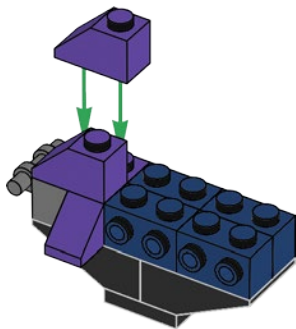

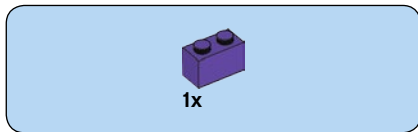

8

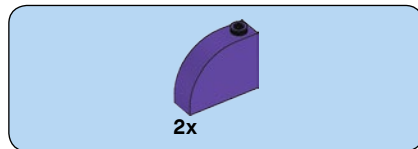
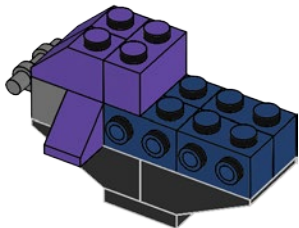

9

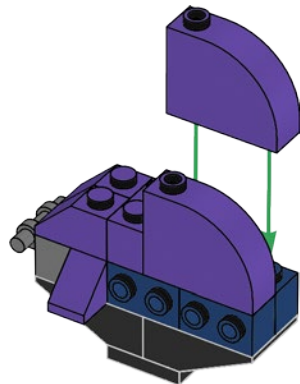



2x

10

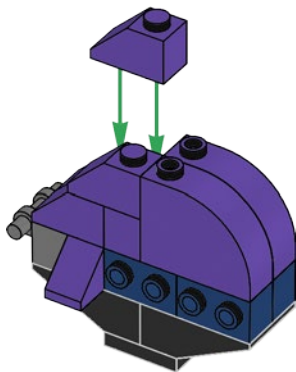



1x



1x

11

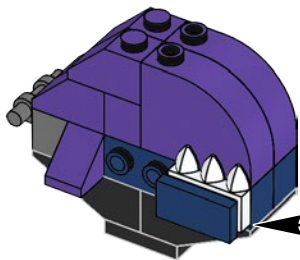
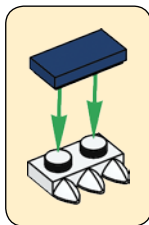

1x



1x

12

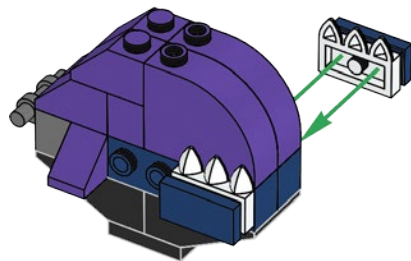
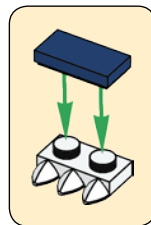

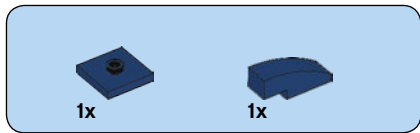

13

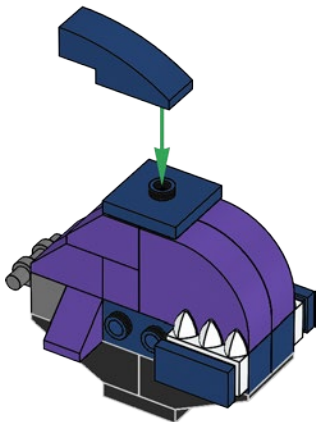



14

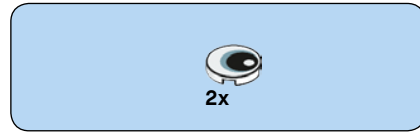
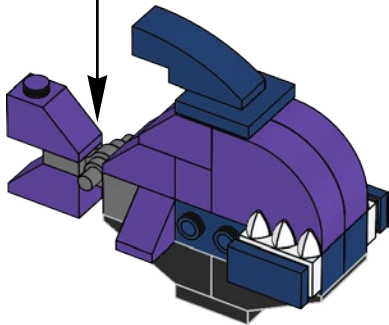
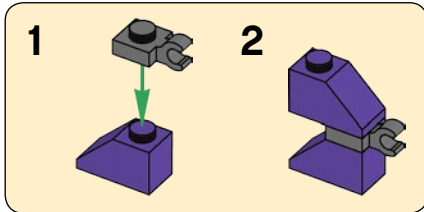

15

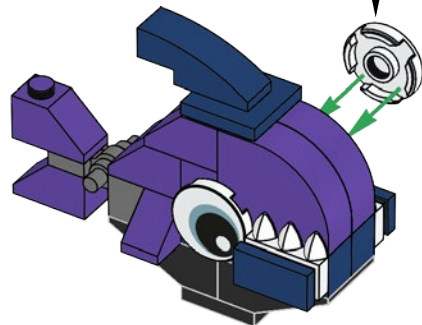
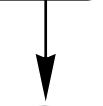



1x

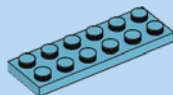

1x

1

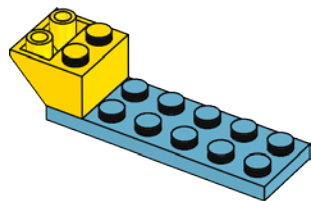



2x

2

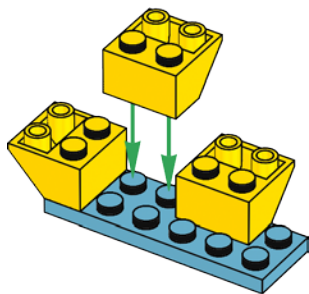

2x

3

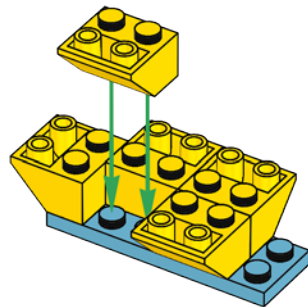



1x

4

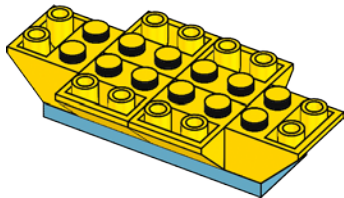

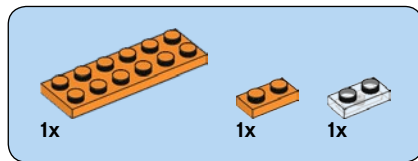

5

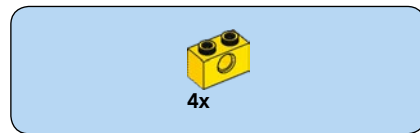
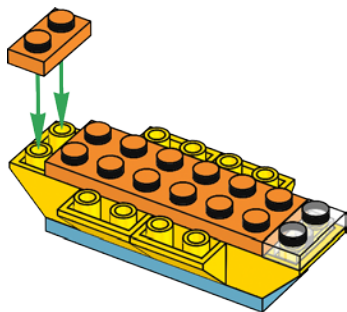

6

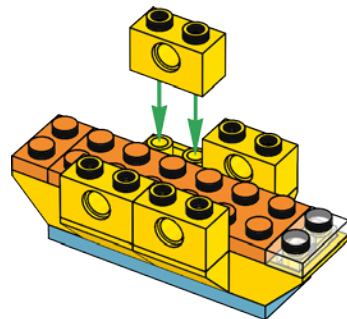

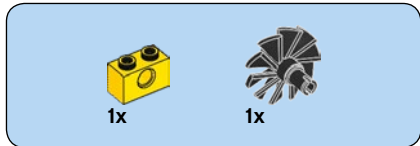

7

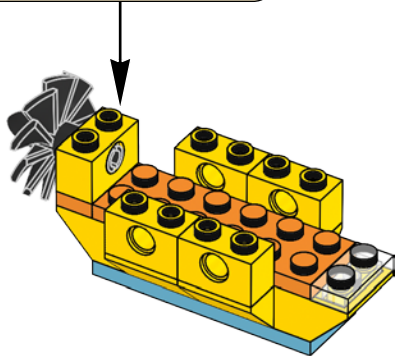
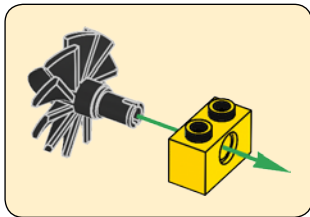

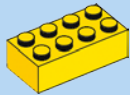

1x

8

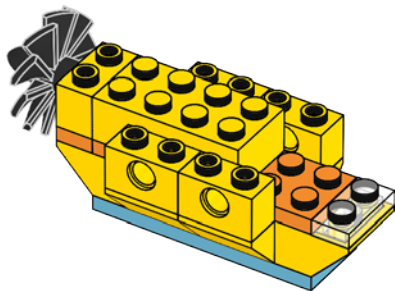

1x



1x

9

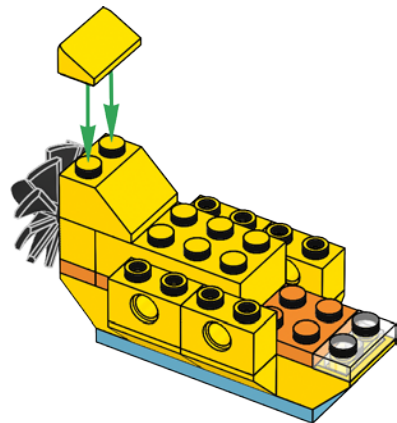



1x



1x

10

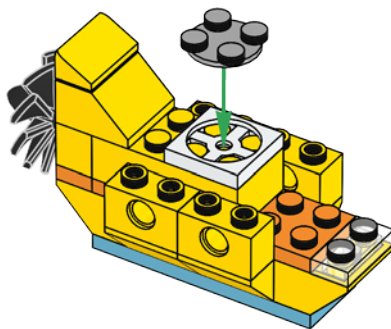



2x

11

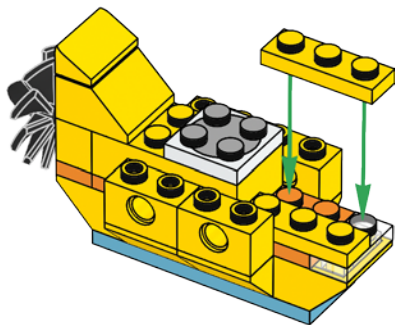

1x

12

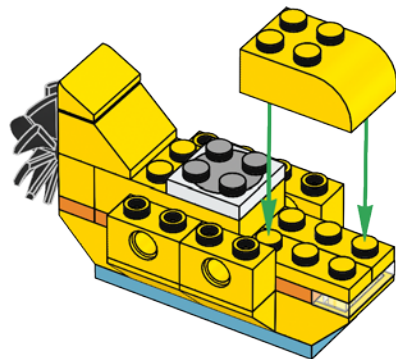



2x

13

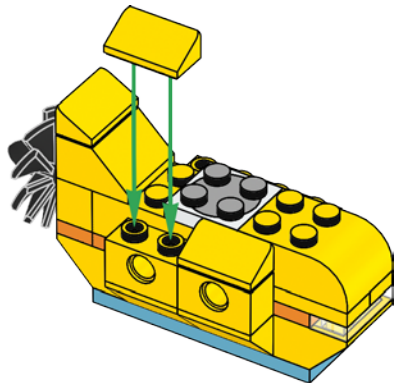

2x

14

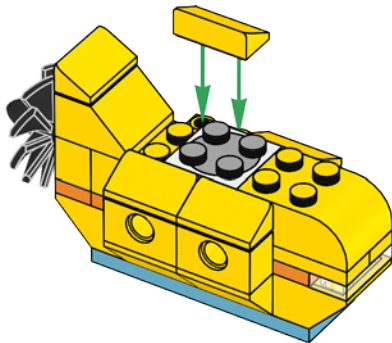



1x



1x

15

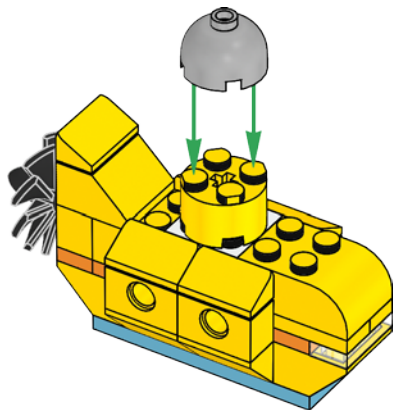

1x



1x



1x

16

1



2

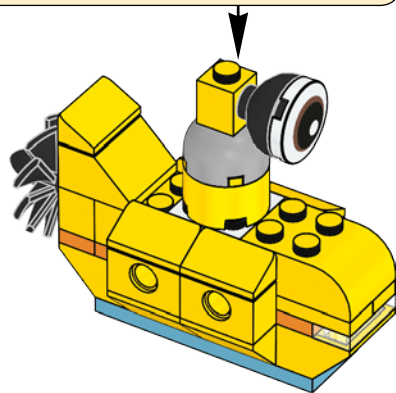

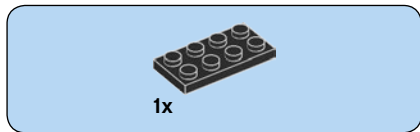

1

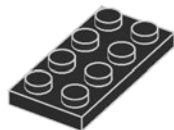

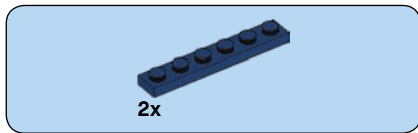

2

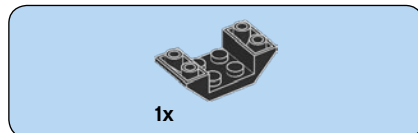
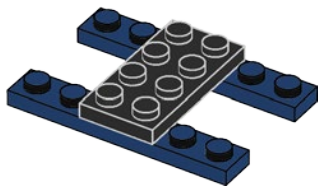

3

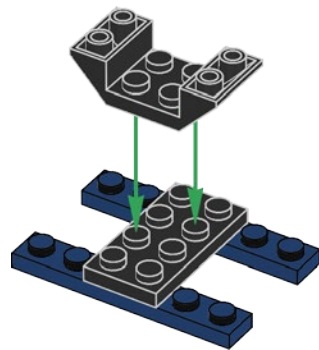



2x

4

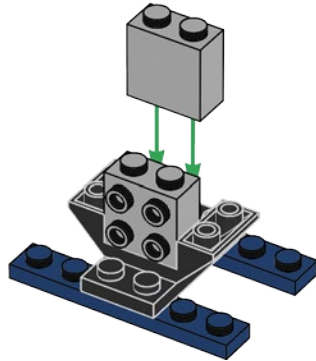



2x



1x

5

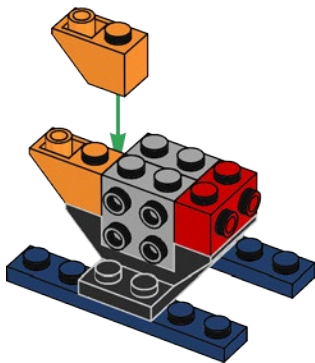

2x

6

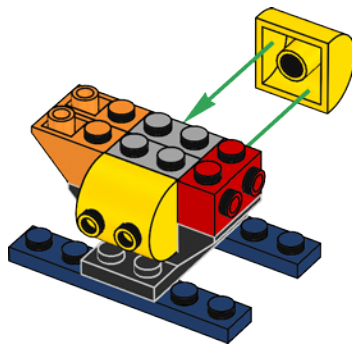

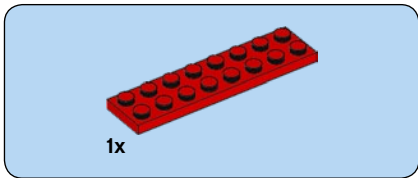
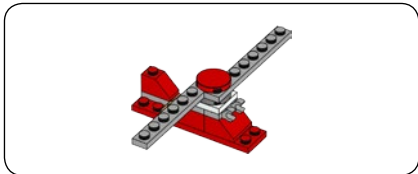

7

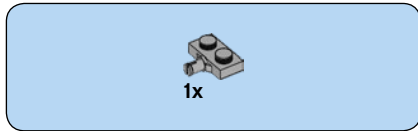
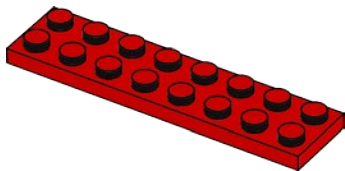

8

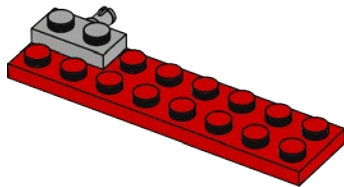



1x



1x

9

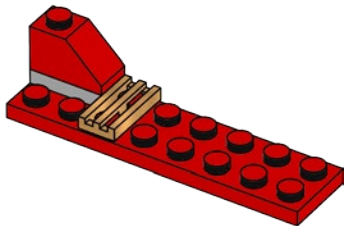

2x

10

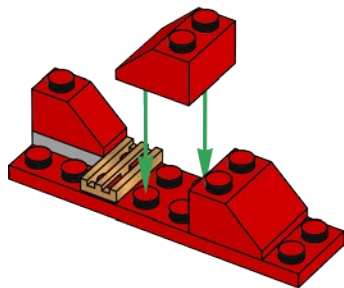



2x



1x

11

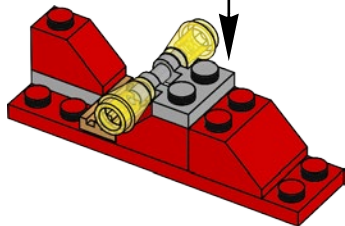
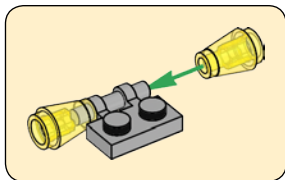

1x

12

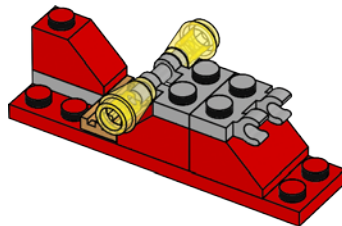



1x



1x

13

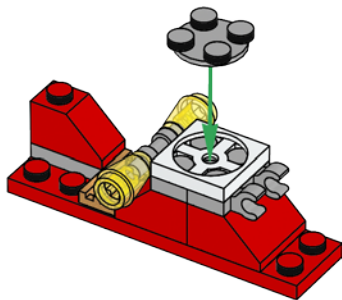

1x

14

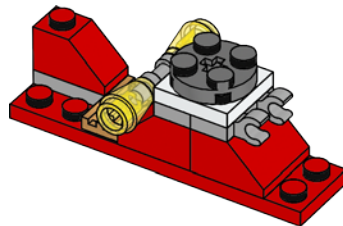

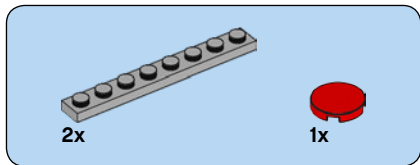

15

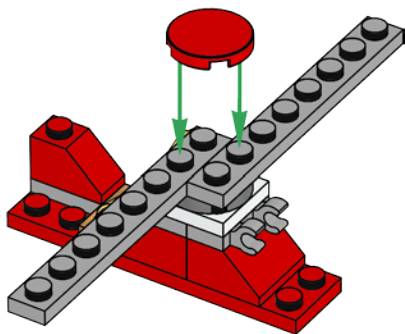

16

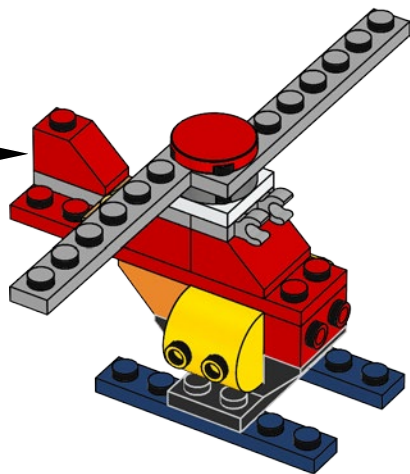



2x

17

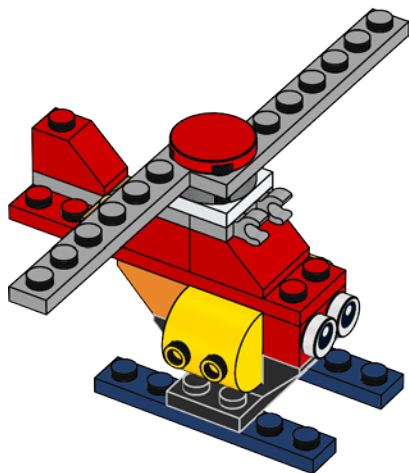

1x



1x

18

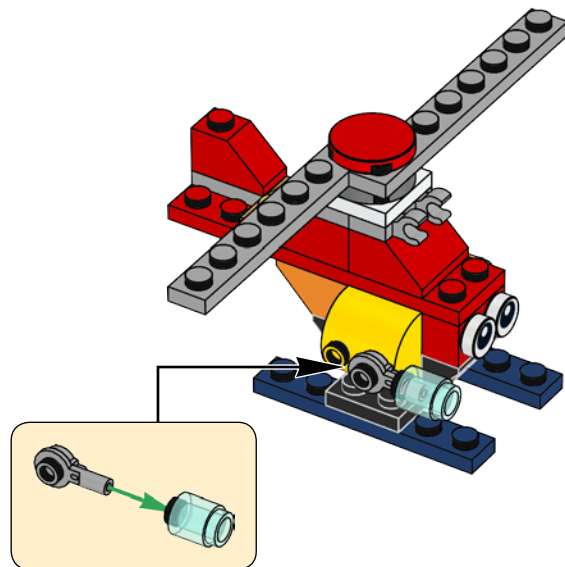



19

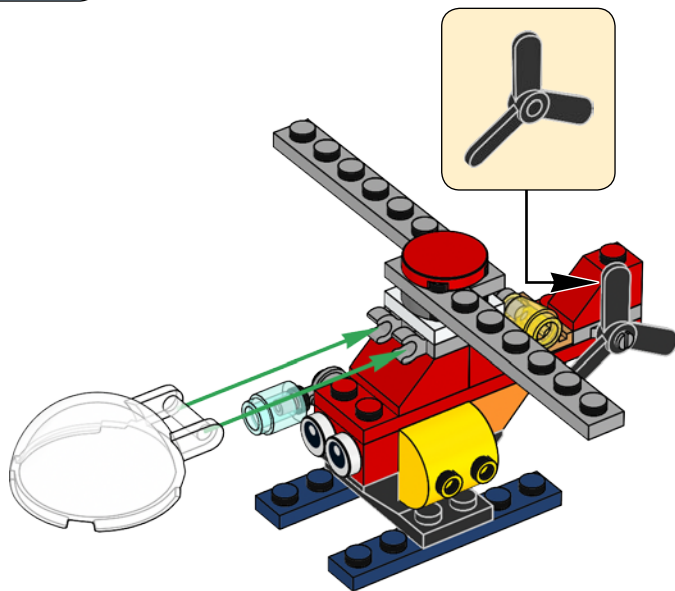

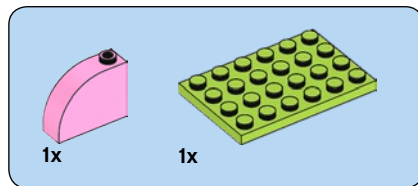

1

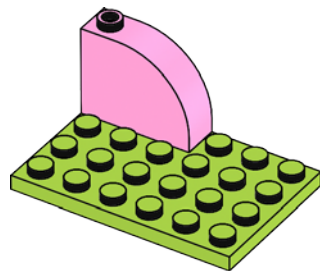



2x

2

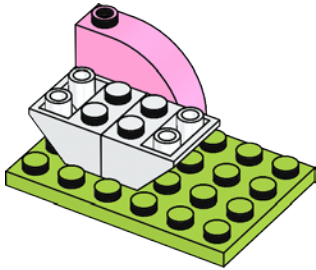

1x



1x

3

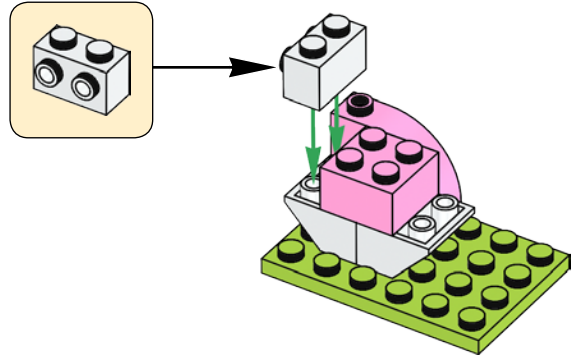

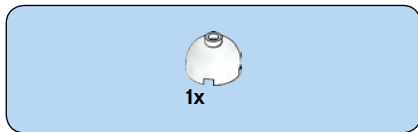

4

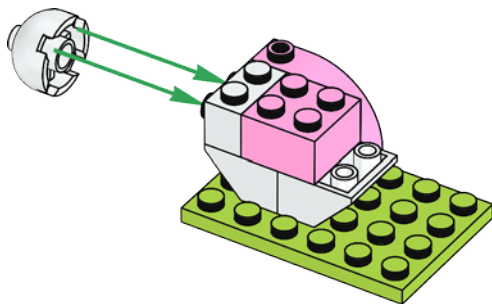

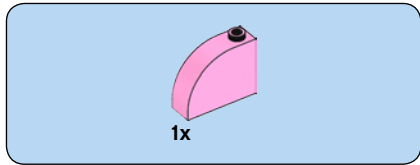

5

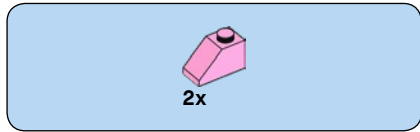
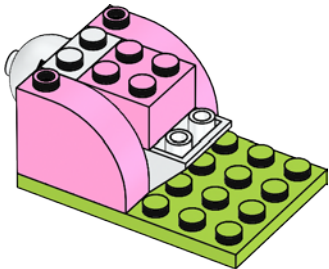

6

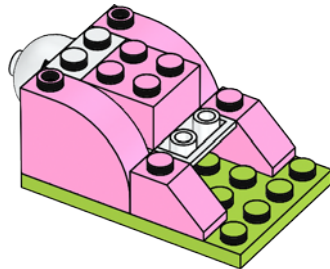



2x

7

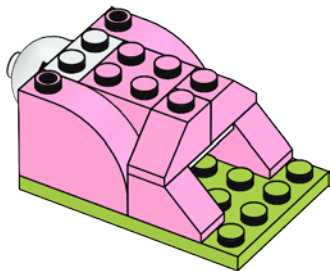

2x

8

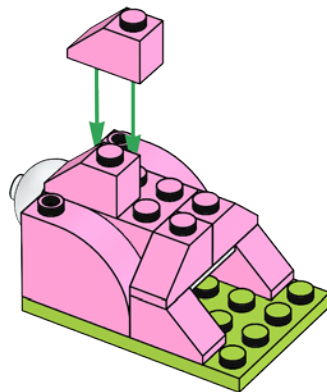

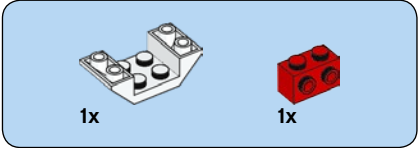
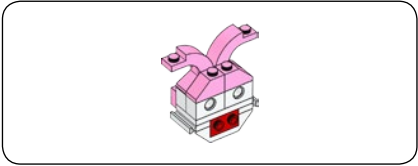

9

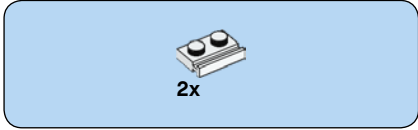
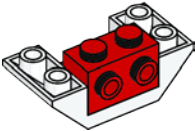

10

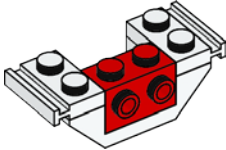

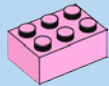

1x

11

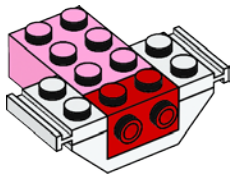

1x

12

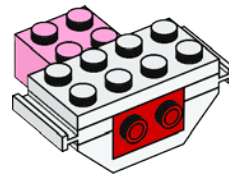

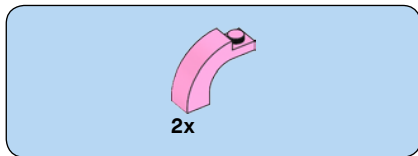

15

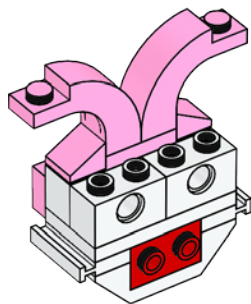

16

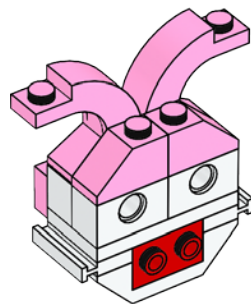

17

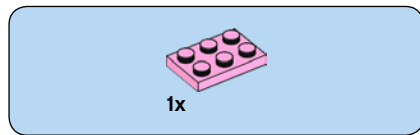
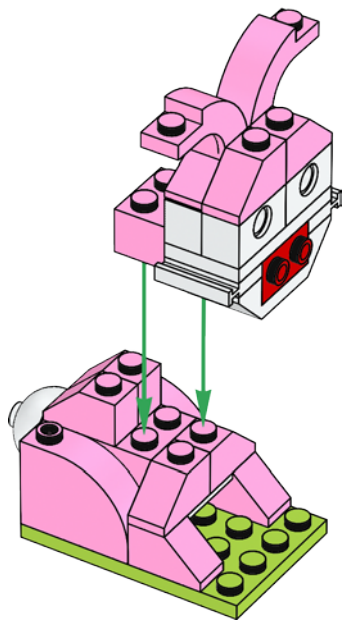

18

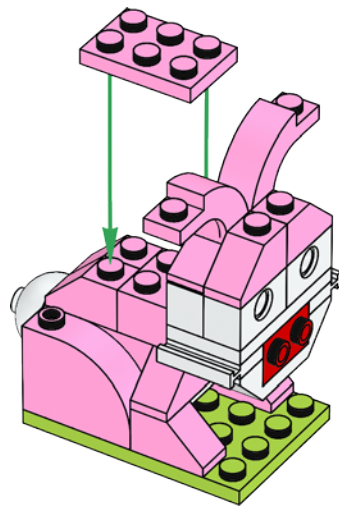



19

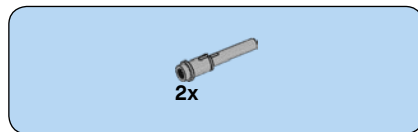
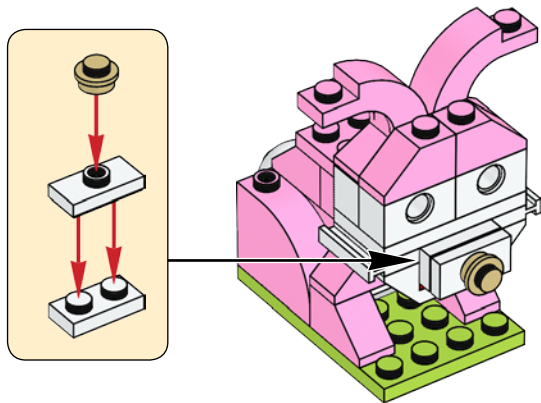

20

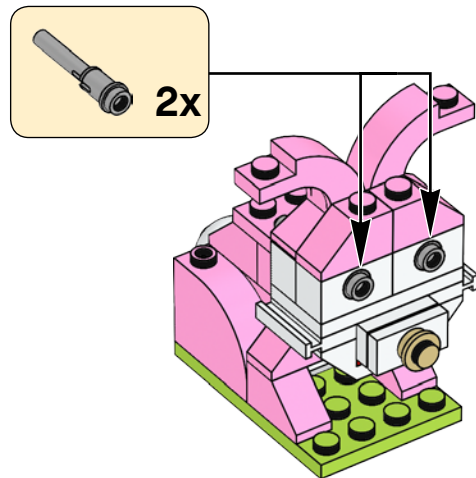



2x

21

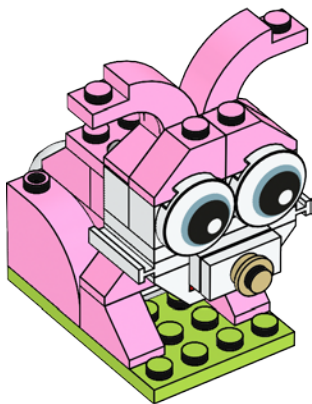

2x



1x

22

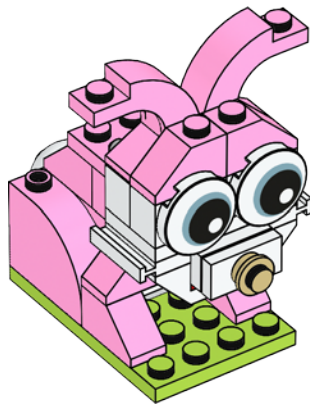

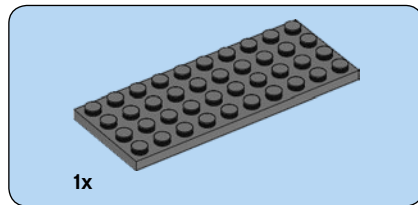

1

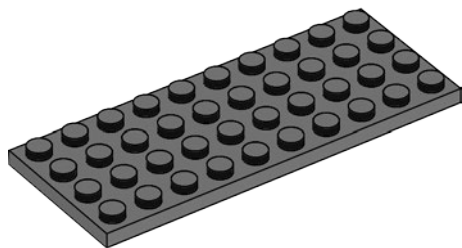



3x

2

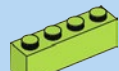
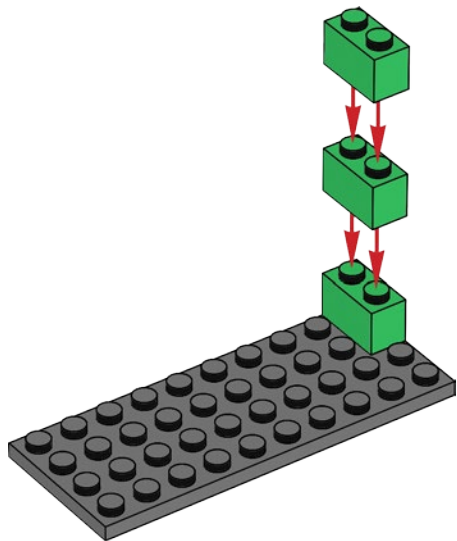

3x

3

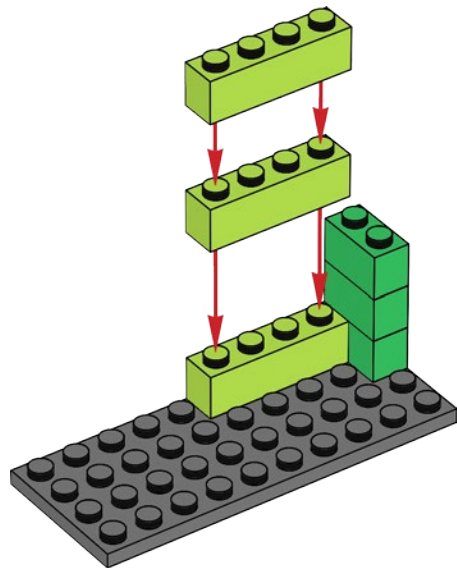

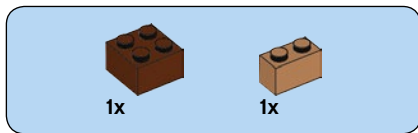

4

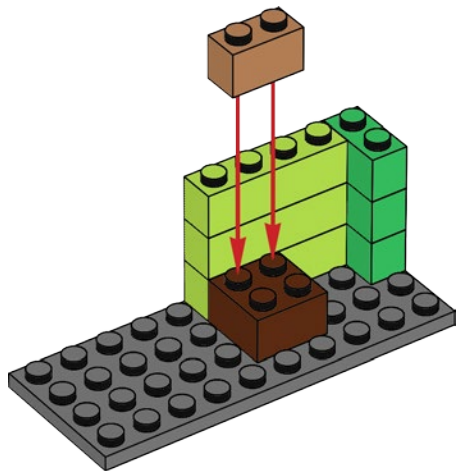

5

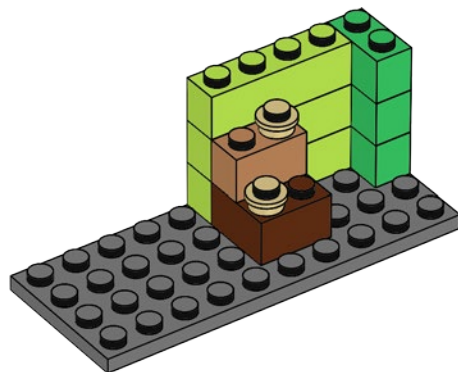

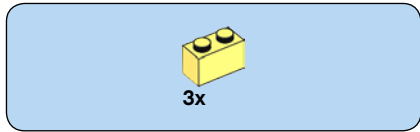

6

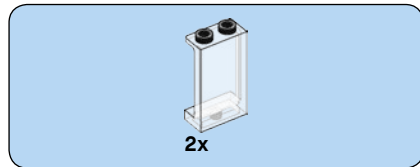
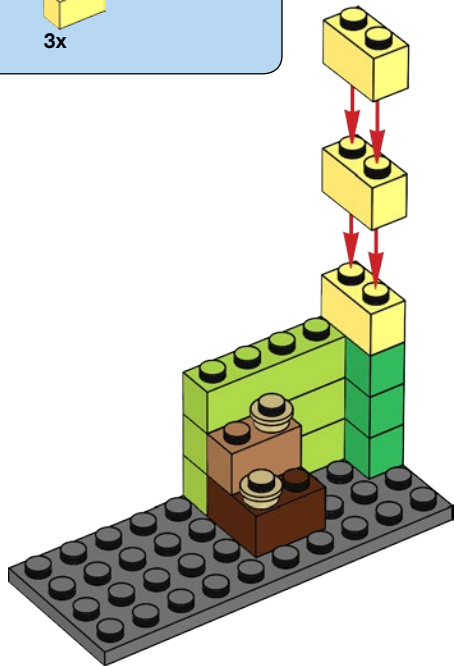

7

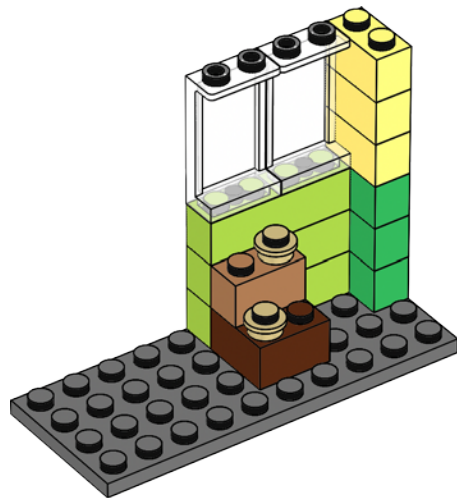

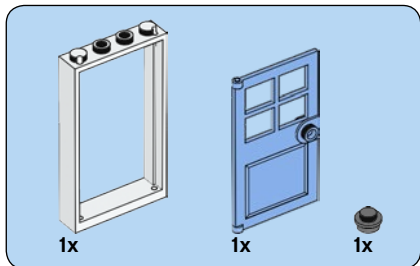

8

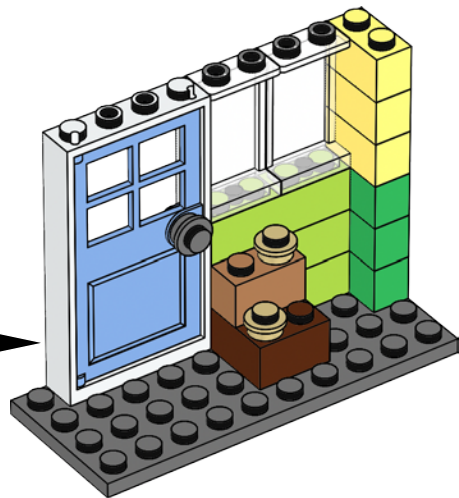
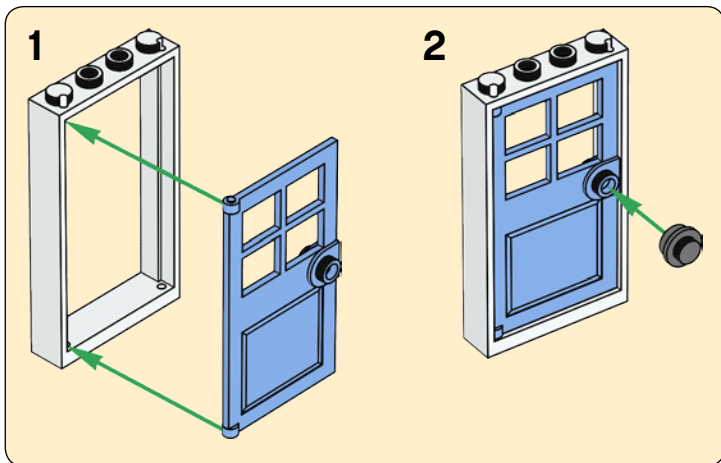



1x

9

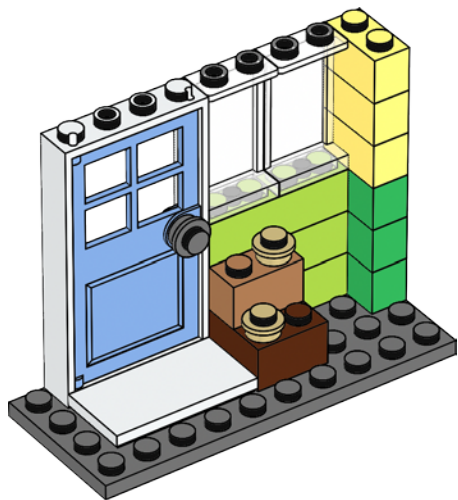

3x

10

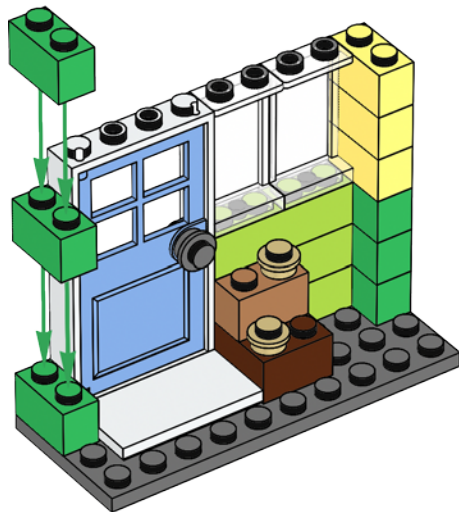



3x

11

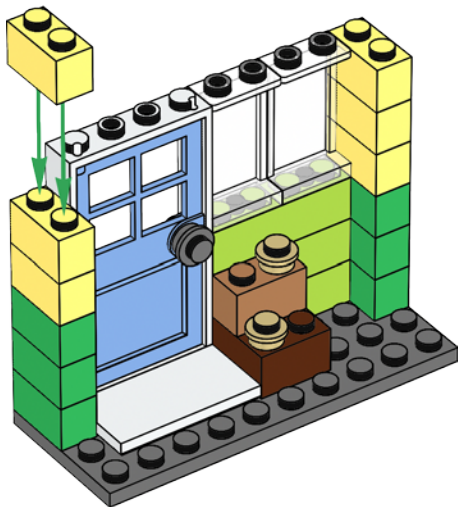

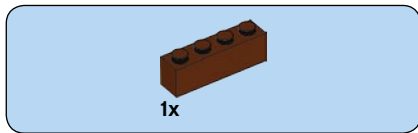

14

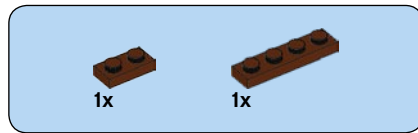
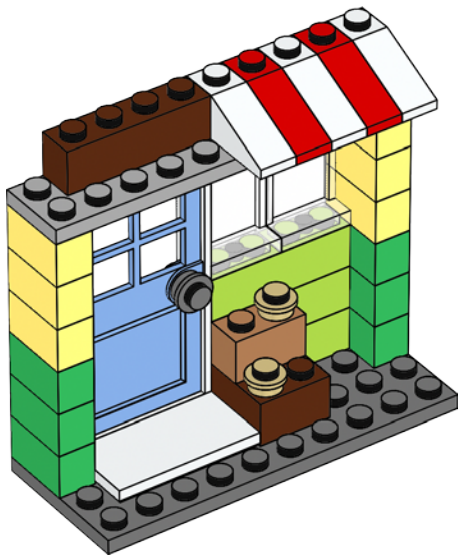

15





2x

16

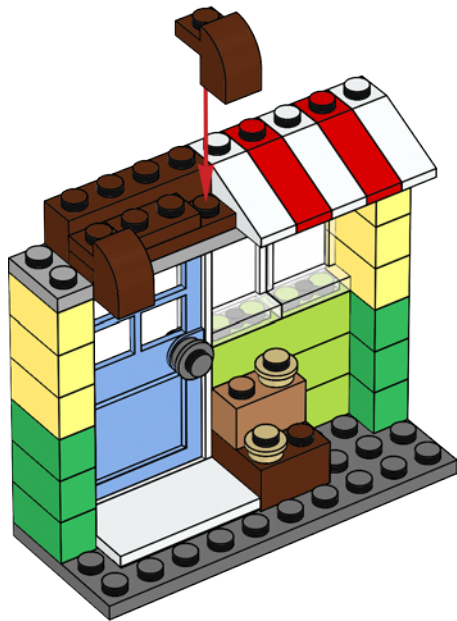

1x

17

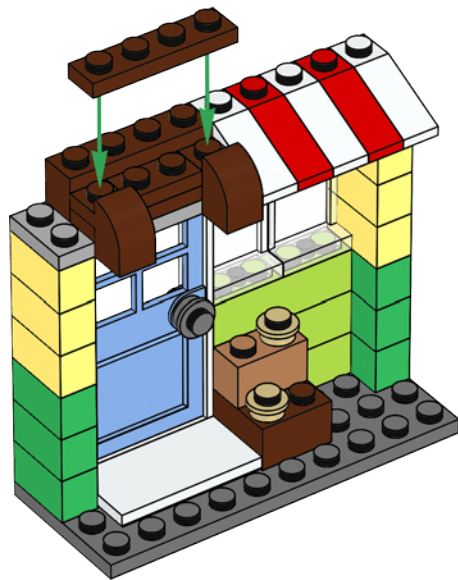



1x

18

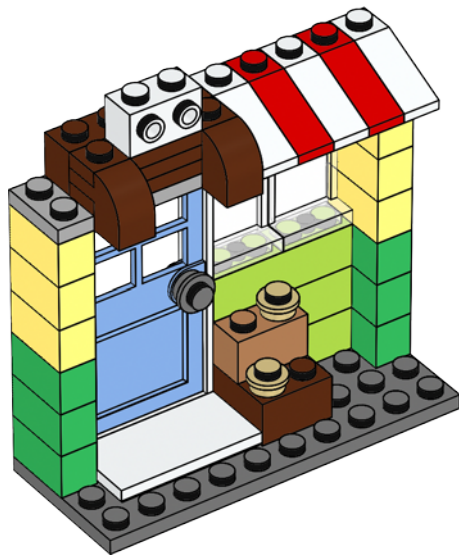

2x

19

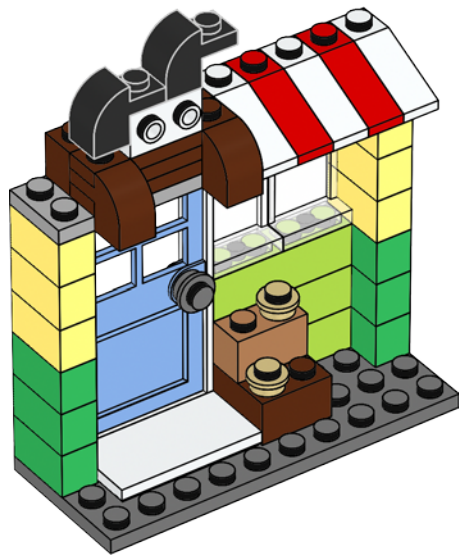

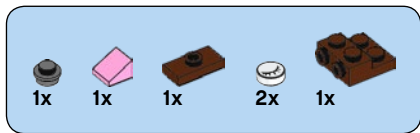

20

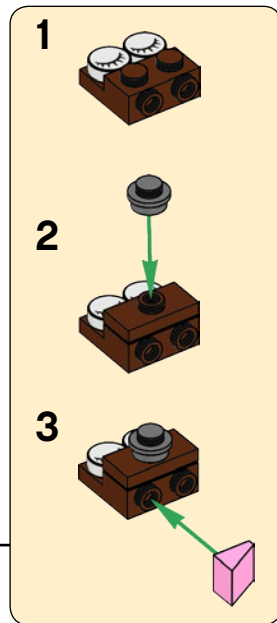
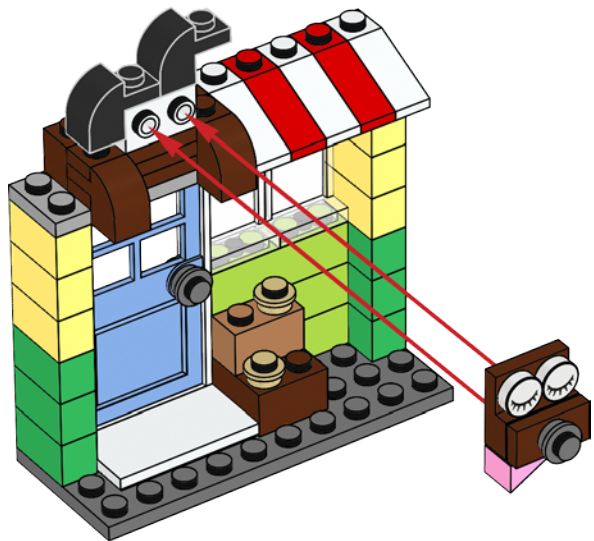



1x

21

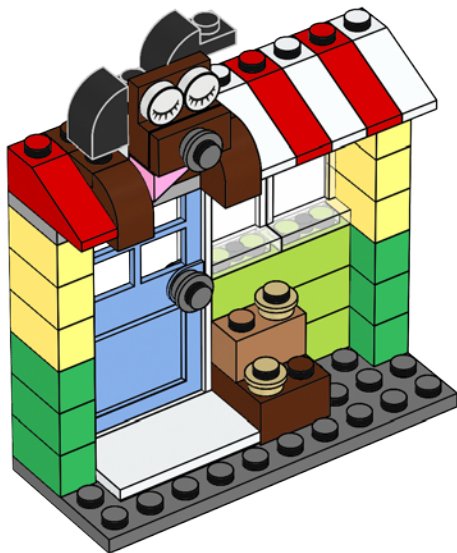

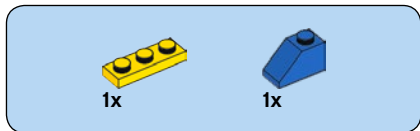
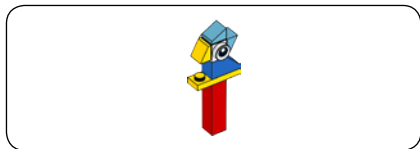

22



23

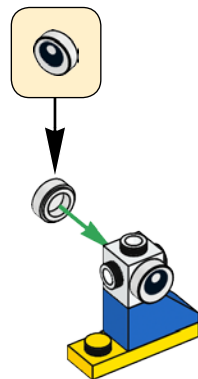

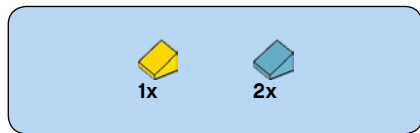

24

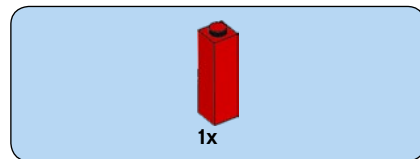
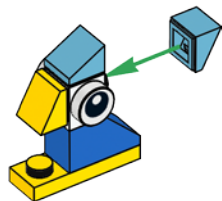

25

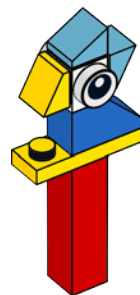

26

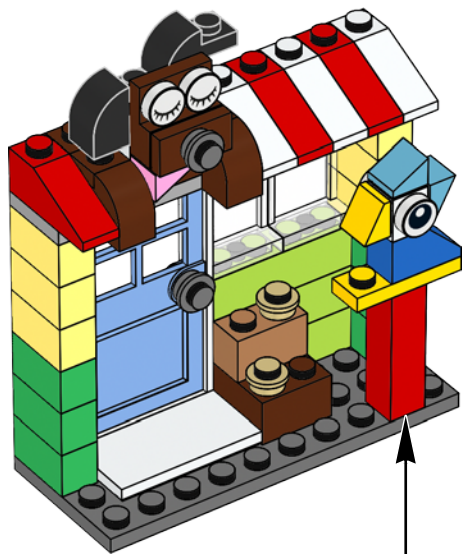



1



2

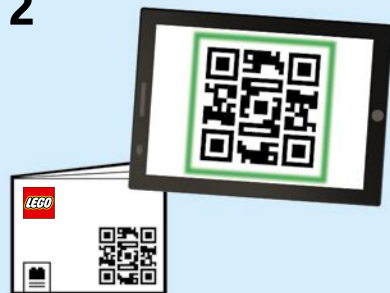

3

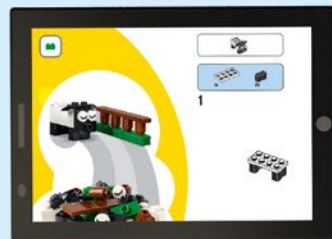



CLASSIC



10698



10696



11002



10713



10700















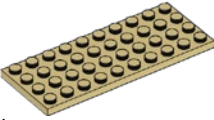

























































10714



10701



[LEGO.com/classic](https://www.lego.com/classic)

 2x 306201	 2x 6051511	 2x 329801	 1x 6037834	 4x 300121	 4x 4624985	 1x 621524	 4x 6184784
 3x 6173629	 1x 302301	 1x 4541956	 1x 6061700	 1x 303421	 1x 4504381	 2x 4164073	 1x 6088638
 3x 6099548	 4x 6046381	 2x 4249563	 1x 6066342	 4x 4583862	 6x 4550348	 2x 300124	 1x 6170693
 7x 6029156	 2x 4249563	 3x 368001	 2x 6019155	 4x 300423	 4x 614324	 3x 307026	 4x 4568644
 7x 6097402	 3x 368001	 2x 302001	 4x 4121934	 2x 302323	 5x 370024	 2x 4273590	 2x 302226
 2x 4111971	 1x 6047220	 2x 4560178	 4x 303921	 4x 4121936	 6x 366024	 2x 6102341	 4x 4582251
 4x 6252746	 4x 300301	 2x 4173943	 4x 428621	 2x 371023	 2x 4187061	 2x 4644456	 2x 374726
 4x 6253320	 4x 366001	 3x 4161734	 1x 302021	 4x 300123	 4x 303924	 2x 249626	 1x 302026
 1x 4216652	 4x 428601	 2x 4114319			 3x 362324	 1x 6092585	
 4x 6058177	 4x 300201						
 4x 370001							

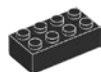

2x
300126



1x
4188534



2x
4529239



4x
6092586



8x
4107736



1x
4565321



1x
302228



1x
621528



1x
371028

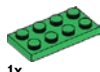

1x
302028

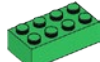

4x
4106356



1x
346028



2x
6211814



2x
6240204



1x
6244781



2x
6238677



2x
6167288



1x
6052993

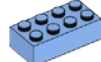

2x
4205058



4x
4518029



4x
4173805



2x
4177932



4x
4121739



4x
4616279



4x
4118828

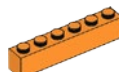

1x
4189007



2x
4121741



1x
6252778

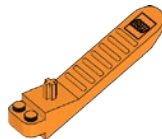

1x
6240515



4x
6073026



4x
4164022



2x
6138122



4x
4234716



1x
4537936



1x
6060848



2x
4528488



4x
6135606



1x
4565320



2x
4540280



2x
4508313



2x
4260493



4x
6245265



2x
6240550



4x
4211183



4x
4211149



2x
6092590



2x
4211150



2x
6035547



4x
4211199



4x
4211210



1x
6146301



2x
4211190



4x
4211225



4x
4211201



1x
4585337



2x
4211412



2x
6168647



3x
6227897



4x
4211764



2x
6152344



1x
4211637



3x
4540203



2x
6125569



1x
4227776



2x
6123809



2x
4556157



2x
4211632



2x
6043639

2x
4520320

2x
4211504

1x
6081975

2x
4211425

1x
4211462

3x
4210633

2x
4579354

2x
4211042

2x
6039479

1x
4211128

1x
4263176

1x
4211122

3x
4599538

4x
4654128

8x
4517995

4x
4550359

2x
6250587

2x
6250647

2x
6102999

4x
4518892

2x
4520632

8x
6022083

4x
6104154

8x
6109814

2x
6173047

2x
4626935

2x
4490599

4x
4569382

2x
6121350

2x
4619520

2x
4625629

1x
6146926

2x
4655173

Customer Service

Kundenservice

Service Consommateurs

Servicio Al Consumidor

LEGO.com/service or dial



: 00800 5346 5555

: 1-800-422-5346

WIN

GO TO WWW.LEGO.COM/PRODUCTFEEDBACK AND
GIVE US YOUR SHORT **FEEDBACK** ABOUT THIS
LEGO® SET FOR A CHANCE TO WIN
A COOL LEGO PRIZE.

Terms & Conditions apply

LEGO.com/productfeedback



GEWINNE

Erzähle uns auf
www.LEGO.com/productfeedback

etwas über die Erfahrungen, die du mit
diesem LEGO® Set gemacht hast, und
sichere dir die Chance auf einen coolen
LEGO Preis!

Es gelten die Teilnahmebedingungen

GAGNE

Rends-toi sur
www.LEGO.com/productfeedback

et donne-nous quelques commentaires sur
ce produit LEGO® pour avoir une chance
de gagner un prix LEGO !

Voir Conditions Générales

GANAN

Visita
www.LEGO.com/productfeedback

y envíanos tu opinión acerca de este set
LEGO®. ¡Participarás en el sorteo de un
premio LEGO!

Términos y Condiciones aplicables

获取奖品

登录
www.LEGO.com/productfeedback

给出关于此乐高®套装的简短反馈，
就有机会获得炫酷乐高奖品

《条款及条件》适用

LEGO and the LEGO logo are trademarks of the LEGO Group. ©2019 The LEGO Group.

6280263